



PRORACK

Powered by PROLINK

We provide customers with satisfactory products and services according to international standards, to meet different customer needs.



Description:

Wall mount cabinet with glass door, 1 fan, 1 shelf and 1 PDU 6 outlet.

Main material:

Cold-rolled steel

Load capacity:

Static load: 800KG

Surface treatment:

Degreasing, pickling, phosphating, laundering, powder coating

Features:

- Exquisite design with precise dimensions and craftsmanship
- Two side panels for each side can be separately open with locks, which are easy to operation and maintenance
- Two back sides with multifunctional cable routing panels
- High-class locks
- Casters and support feet can be installed simultaneously
- Optional pedestals for fixation, cable routing, ventilation, and rat proof
- Curved front screen door & back double screen door enable equipment to ventilate well
- Various optional accessories
- Pro-Rack logo is printed on the side panel

Structure

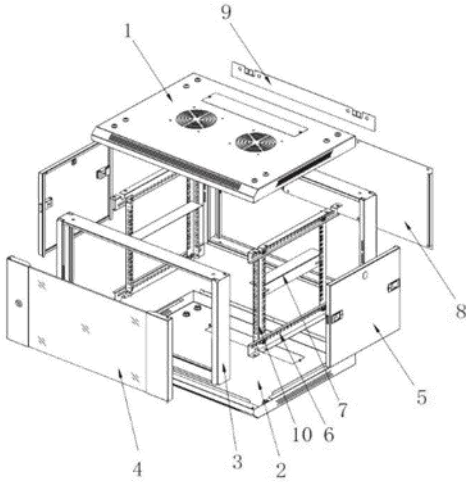

1. Top cover
2. Bottom plate
3. Frame
4. Front door
5. Side panel
6. Horizontal bracket
7. L-shaped bar
8. Back panel
9. Mounting panel
10. Profile Rail

Size

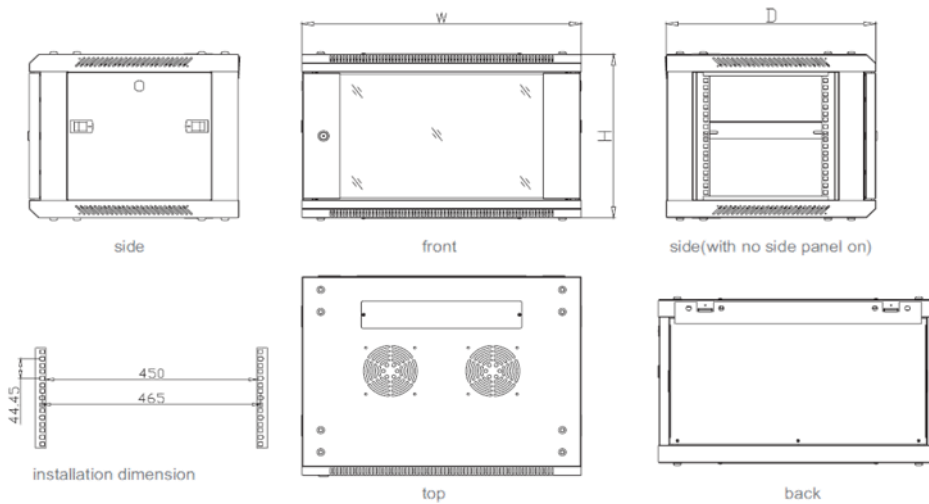

Installing

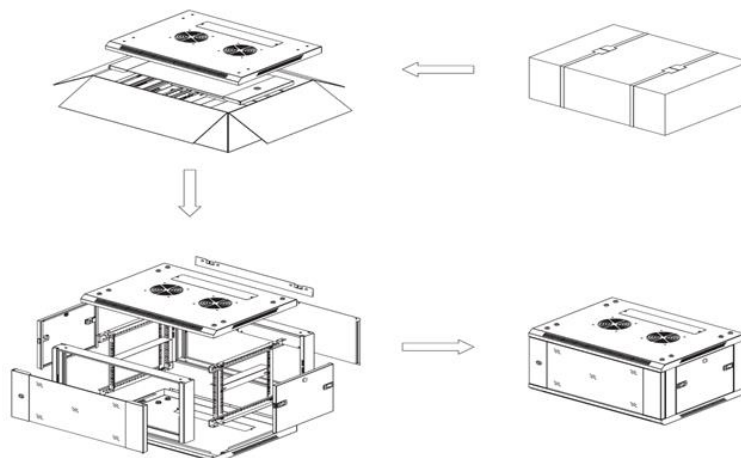

Technical parameters:

NANES	QUANTITY	UNIT	MATERIALS	SURFACE TREATMENT	REMARKS
Top Covers	1	Pc	1.0mm cold-rolled steel	powder coating	
Bottom plates	1	Pc	1.0mm cold-rolled steel	powder coating	
Frames	2	Pc	1.0mm cold-rolled steel	powder coating	
Front doors	1	Pc	5mm tempered glasses 1.2mm cold-rolled steel	powder coating	Glass Door Type B
Side panels	2	Pc	1.2mm cold-rolled steel	powder coating	
Horizontal brackets	4	Pc	1.2mm cold-rolled steel	powder coating	
L-shaped panels	2	Pc	1.2mm cold-rolled steel	powder coating	
Back panels	1	Pc	1.0mm cold-rolled steel	powder coating	
Wall hanging panels	1	Pc	1.2mm cold-rolled steel	powder coating	
Profile rails	4	Pc	1.5mm cold-rolled steel	powder coating	
Cage nuts	20	Pc		powder coating	
Sockets with 6 outlet	1				
Fans	1	Pc	1.2mm cold-rolled steel	powder coating	
Shelves	1	Pc	1.2mm cold-rolled steel	powder coating	

TYPES	PR-W6409
CAPACITY (U)	9U
WIDTH	600
DEPTH	450
HEIGHT	370
WHOLE PACKAGE	
WIDTH	620
DEPTH	470
HIGHT	390
VOLUME (M ³)	0.114
FLAT PACKAGE	
PACKAGE	620*530*250
VOLUMES (M ³)	0.073
Front Door	Glass

Color:

 **BLACK (RAL9005)**